



## ***CRE-2100***

ELECTRA-RIDE<sup>™</sup> III  
STAIRWAY ELEVATOR

### **Operator's Manual**

**Technical Service email: [service@bruno.com](mailto:service@bruno.com)  
[www.bruno.com](http://www.bruno.com)**

1780 EXECUTIVE DR., P.O. BOX 84, OCONOMOWOC, WI 53066 USA  
TELEPHONE: (262) 567-4990  
FAX: (262) 953-5501  
1-800-882-8183  
REV. 03-12-2007

## PRODUCT REGISTRATION FORM

**BRUNO**  
for your independence

**Product Registration Form**  
Please print in CAPITAL letters.

! Please be assured that Bruno **does not** share or sell the information you provide.

Last Name \_\_\_\_\_

First Name \_\_\_\_\_ M.I. \_\_\_\_\_

Street Address \_\_\_\_\_  
include apartment no, suite no.

City \_\_\_\_\_ State \_\_\_\_\_

Zip/Postal Code/Country \_\_\_\_\_

Email Address \_\_\_\_\_

Telephone No. \_\_\_\_\_

Date of Purchase (mm/dd/yy) \_\_\_\_\_

Installer (if different than seller) \_\_\_\_\_

**Where did you hear about Bruno? CHECK ALL THAT APPLY.**

doctor/therapist  radio

Bruno dealer  AARP publication

Internet  other (please tell us): \_\_\_\_\_

local newspaper \_\_\_\_\_

**Who was the primary decision maker for this purchase?**

user of product  care giver

family member  doctor/health care provider

friend \_\_\_\_\_

**Which of the following health issues are of concern to you? CHECK ALL THAT APPLY.**

spinal injury  post polio

arthritis  muscular dystrophy

diabetes  multiple sclerosis

stroke  emphysema

other (please tell us): \_\_\_\_\_

**Please rate your satisfaction with your Bruno dealer:**

excellent  good  average  poor

**Please rate your satisfaction with your Bruno product:**

excellent  good  average  poor

Bruno reserves the right to use comments indicated on this form in its on-line, video, audio and printed materials. Names will be abbreviated to ensure the privacy and anonymity of the individual.

©2006,2005 Bruno Independent Living Aids, Inc.® Rev. 10/06

Bruno is pleased to provide you with this mobility-enhancing product.

The Product Registration Form is shipped in a plastic bag with this manual. It is very important that you fill out and return this form at your earliest convenience so that we may complete the warranty registration process for your unit.

The **serial number** is found on labels affixed to the manual, as well as on the unit itself.

**Serial and model numbers must be provided** when filing a warranty claim, requesting service or ordering parts. We encourage you to keep this information readily available at all times.

Please Note: The warranty for the CRE-2100 Stairway Elevator is *rendered null and void* if the unit is installed by anyone other than an authorized Bruno dealer.

Best wishes from the Bruno Team.

CRE-2100 Operator 03-12-2007

## **Table of Contents**

FCC Regulations and Specifications . . . . .	4
Safety . . . . .	5-6
Parts of the CRE-2100 . . . . .	7
Circuit Breaker . . . . .	8
Seating . . . . .	9
Operation . . . . .	10
Charging . . . . .	11
Battery Charger. . . . .	12-13
Maintenance and Transmitter Battery Replacement . . . . .	14
Troubleshooting. . . . .	15-16
Vacation and Long-Term Storage . . . . .	17
Warranty . . . . .	18-19

## **FCC REGULATIONS**

This equipment has been tested and found to comply with the limits for a Class B digital device, pursuant to Part 15 of the FCC rules. These limits are designed to provide reasonable protection against harmful interference in a residential installation. This equipment generates, uses, and can radiate radio frequency energy, and if not installed and used in accordance with the instructions, may cause harmful interference to radio communications. However, there is no guarantee that interference will not occur in a particular installation. If this equipment does cause harmful interference to radio or television reception, which can be determined by turning the equipment off and on, the user is encouraged to try to correct the interference by one or more of the of the following measures:

- Reorient or relocate receiving antenna.
- Increase separation between equipment and receiver.
- Consult your dealer.

## **SPECIFICATIONS**

*Weight Capacity:* 350 lbs. (159 kg)

*Control:* constant pressure (armrest and two remotes)

*Maximum Incline:* 45 degrees

*Seat Swivel:* 0, 30, 60 and 90 degrees, both directions, at top and bottom

*Power Supply:* 24VDC battery charger powered by 120V outlet

### **FOR YOUR SAFETY**

- Read and understand the operating instructions, and all safety precautions prior to using the CRE-2100.
- Be sure stairs are clear of objects before operating the stairway elevator.
- Always be aware of the surface onto which you are stepping as you get on and off the stairway elevator.
- Avoid carrying items with you on the stairway elevator which could hinder movement of the elevator up and down the stairs.
- Do not wear LOOSE clothing that could interfere with elevator movement.
- Fasten your positioning belt before operating the stairway elevator.
- Make sure the seat is locked in the correct riding position.
- Be certain the seat swivel is locked in place before attempting to get on or off the stairway elevator.

## **FOR YOUR SAFETY**

Each stairway elevator is designed to descend the stairway at a slightly slower speed than is the case when travelling UP. The maximum speed of the carriage can be adjusted by your installer.

The footrest is equipped with *obstruction sensors* which stop the carriage if an obstacle is encountered on the stairs.

If this should occur, press the opposite side of the UP/DOWN rocker control switch (on the armrest) to run the carriage in the opposite direction. Clear the obstacle from the stairway or rail then resume travel in the desired direction.

Your CRE-2100 is battery powered and will continue to operate for some time during a power outage. The length of operation will depend on the battery condition, the length of the stairs and the weight of the rider.

*Only in the event of a prolonged power outage (more than one hour) will it be necessary to turn the power off (circuit breaker switch on the carriage) and unplug the charger from the wall outlet to conserve battery charge.*

## CRE-2100

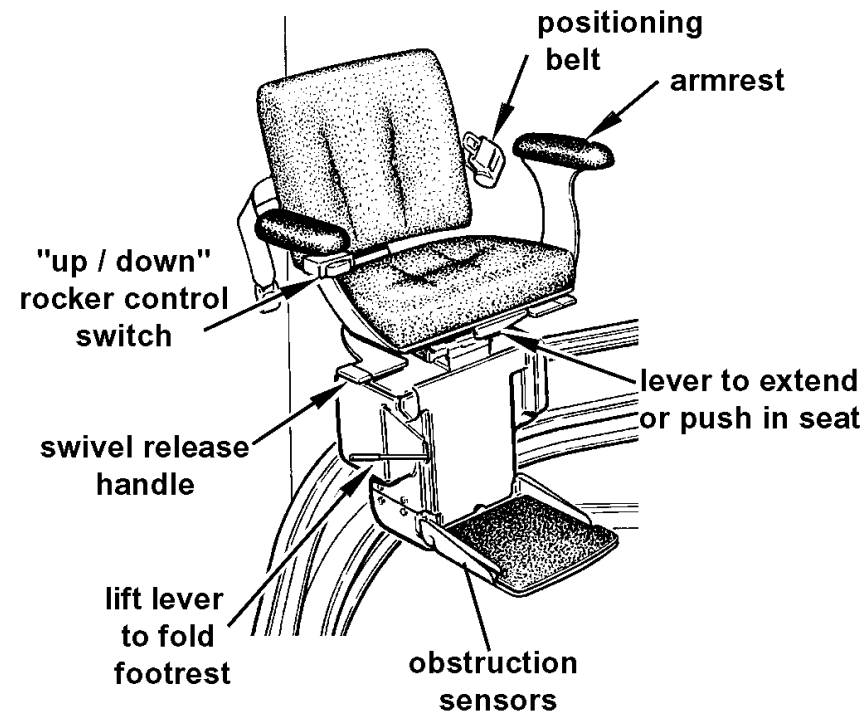

## CIRCUIT BREAKER

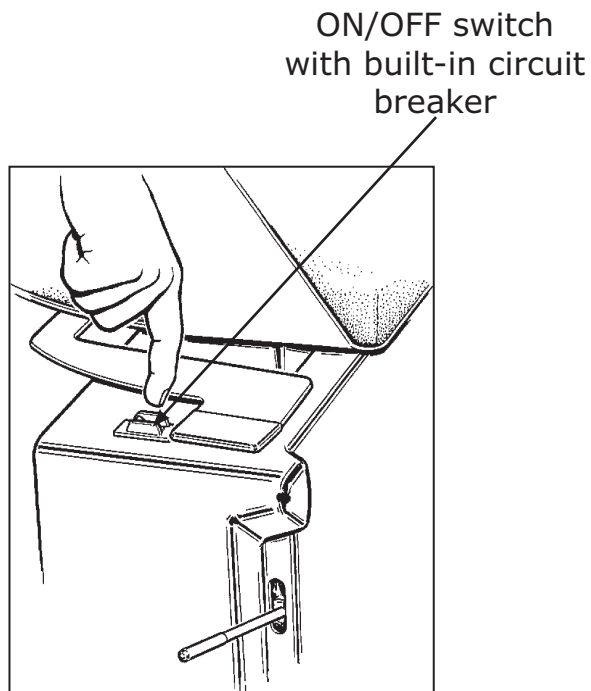

The CRE-2100 includes an ON/OFF switch with a built-in circuit breaker.

The circuit breaker protects the battery, controller and motor circuits in the stairway elevator carriage.

It is unlikely that this circuit breaker will trip during normal use. However, if the elevator becomes inoperative, check the circuit breaker as a first troubleshooting step. Reset it, if necessary.

Possible causes of circuit breaker tripping:

- foreign object jamming the rail or gear rack;
- exceeding the rated weight capacity of the stairway elevator.

## SEATING

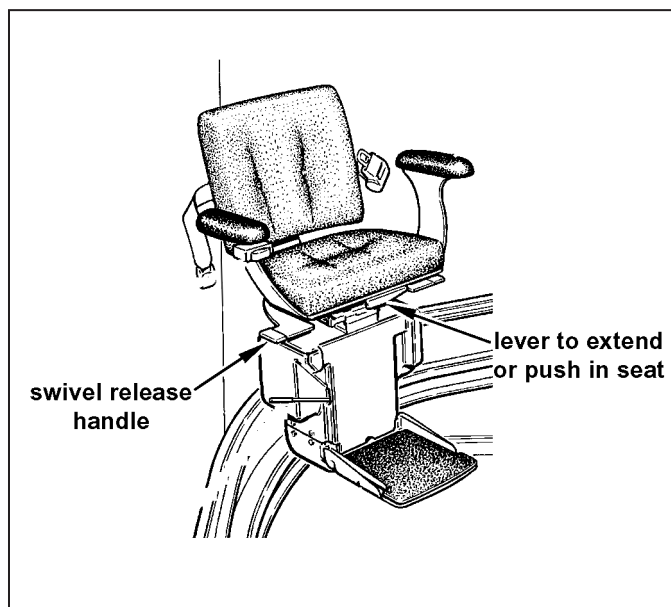

The CRE-2100 seat assembly (with standard armrests) is designed to swivel a total of 180 degrees.

It locks in the center (home) position, and in positions *30, 60 and 90 degrees to the right and to the left of the center position.*

Lift up on the swivel lever located under the seat (either side) to swivel the seat to a convenient position for transferring into or out of the seat.

Once you release the swivel lever, the seat will lock in the closest of the five positions indicated above.

The seat also slides forward to make transferring easier. Simply push in the lever located just below the front of the seat cushion and slide the seat out or in.

## OPERATION

The CRE-2100 includes a "**soft-start**" feature which prevents the unit from moving abruptly the instant the UP/DOWN switch is pressed.

Press and hold the switch for a moment to begin the gentle acceleration of the stairway elevator to operating speed.

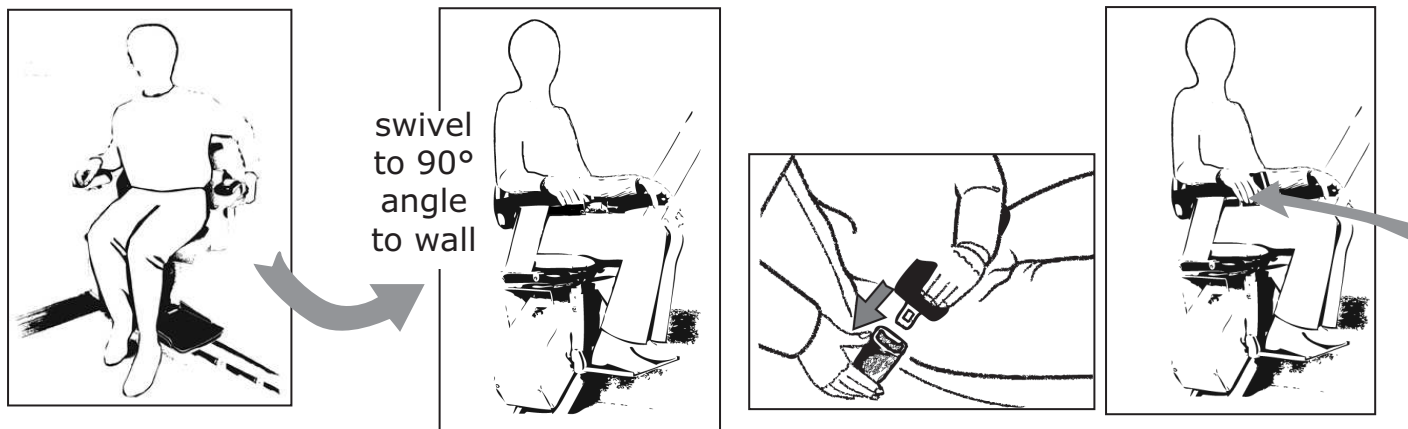

## CHARGING

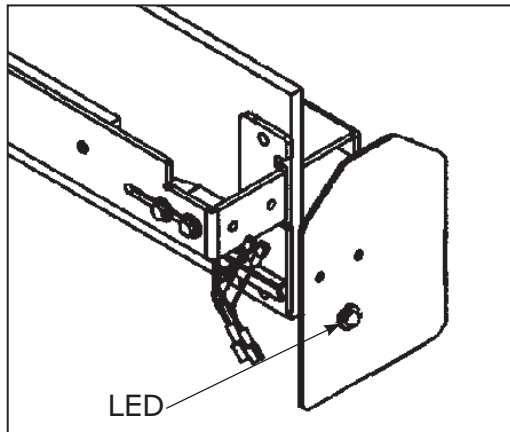

glowing LED = charging

**Keep the batteries charged** to ensure optimal operation of your CRE-2100.

The batteries are charging whenever the carriage is parked tightly against the brackets at either end of the rail. Whenever the carriage does not contact the upper or lower charge bracket, the batteries will slowly discharge.

Failure to keep the batteries charged, or allowing them to fully discharge, will significantly shorten the life of the batteries.

Therefore, when the stairway elevator is not in use, park the carriage at either end of the rail, making sure it touches the charge bracket contacts.

The yellow LED light on the upper and lower charge brackets glows when the carriage is correctly parked against the contacts.

If your application prevents parking the carriage at one or the other end of the stairs (for example, a door at the top of the stairs), *ALWAYS* use the call/send transmitter to move the carriage to the end of the rail where the carriage *can* contact the charge bracket. Using the transmitter, call it back to the other end of the stairs when needed.

## BATTERY CHARGER LED'S

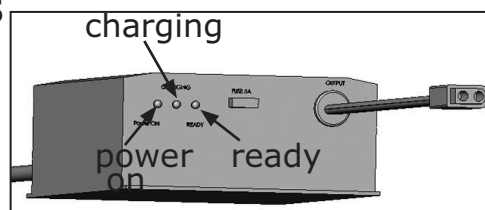

<b>RED</b>	<b>YELLOW</b>	<b>GREEN</b>	<b>STATUS</b>
ON	OFF	OFF	charger not connected to battery (AC power ON, no battery connected)
ON (5 sec.)	ON (5 sec.)	ON (5 sec.)	battery disconnect situation detected (AC power ON, battery disconnect); 10-second delay until yellow and green LED's completely off
ON	ON	OFF	charger at maximum voltage/ delivering maximum current
ON	SLOW BLINK	SLOW BLINK	batteries close to being fully charged
ON	ON	ON	batteries fully charged
ON	BLINK	OFF	low voltage indication
ON	OFF	FAST BLINK	battery defective or heavily sulfated

## BATTERY CHARGER FUSE REPLACEMENT

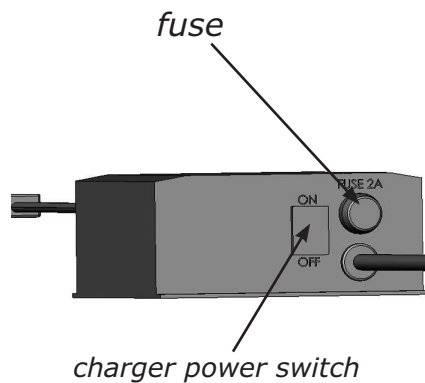

If the charger is subject to a power line surge, the AC input fuse may blow. Refer to the illustration to the left for fuse location.

### ***To replace fuse:***

1. Turn OFF the battery charger power switch.
2. Remove power cord from wall outlet.
3. Twist the fuseholder cap and pull out to remove the fuse.
4. Replace with the same size and type fuse: (BUSS # GSL 2) 5 x 20mm.

## MAINTENANCE

Your CRE-2100 is designed to provide many years of reliable service with minimal maintenance.

For best service life:

- Keep the rail channel clean and free of debris.
- Always park the carriage at one end of the rail so that the batteries charge when the elevator is not in use.
- Keep the battery charger plugged into a live outlet at all times.
- **At least once a year**, have the elevator examined, cleaned and lubricated by a qualified, authorized Bruno service technician.

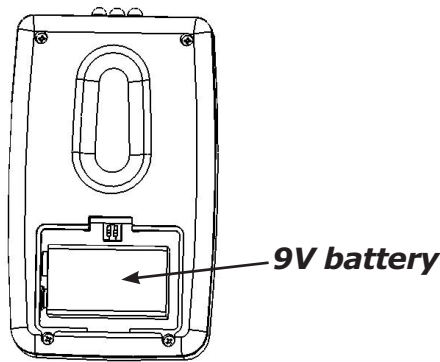

back of transmitter  
with battery access  
cover removed

### **TRANSMITTER BATTERY REPLACEMENT**

- Detach the transmitter from the wall.
- From the *back* of the transmitter, remove the battery access cover.
- Remove the old battery and replace with a new one.  
**One 9V battery required.**
- Put the access cover back on the transmitter.
- Reposition the transmitter on the wall.

## TROUBLESHOOTING

*Your CRE-2100 is not operating correctly. What should you do?*

*Before calling your Bruno dealer, refer to the solutions listed below. This could save you an unnecessary service call!*

- **Seat swivel.** Is the seat locked in the riding position?
- **Footrest.** Is there an obstruction on the stairway that the footrest is contacting?
- **Carriage safety panels.** Is there an obstruction on the stairway that the carriage safety panels are contacting?
- **Main circuit breaker (or fuse) panel of residence.** Has a breaker tripped or a fuse blown?
- **Battery charger.** A discharged battery will cause the carriage to move more slowly until the voltage drops to the point where the controller will shut off. If this should occur, pause for a moment, then run the carriage down until the unit contacts the upper or lower charge bracket.  
*Partially charged batteries will run the carriage down, but not up.*

Continued on next page.

## TROUBLESHOOTING (CONTINUED)

- **Battery charger (continued).** Confirm that the charger is plugged into a live outlet and wait for the batteries to charge.  
Is the charger plugged into a functional outlet? *Do not use outlets which are controlled by a wall switch.*  
Is the red power light on?
- **Visual check.** Do you notice anything about your elevator that is different or out of place?

If your CRE-2100 continues to function improperly or not at all after completing the preceding checklist, contact an authorized Bruno dealer to perform all required service, repair and maintenance operations.

## VACATION AND LONG-TERM STORAGE

If the CRE-2100 will remain unused for an extended period of time, turn off the circuit breaker, then unplug the battery charger from the wall outlet.

**NOTE:** *The batteries may require recharging before normal use if the stairway elevator remained unused for an extended period of time.*

To recharge, simply turn on the circuit breaker, reconnect the charger to the wall outlet and wait until the charger LED's indicate that the batteries are fully recharged.

**FIVE YEAR MAJOR COMPONENTS WARRANTY  
TWO YEAR LIMITED WARRANTY  
for  
Bruno Stairlifts**

Bruno Independent Living Aids, Inc. ("Bruno"), warrants to the original purchaser of a Bruno Stairlift that the Bruno Stairlift is free from defects in material and workmanship for a period of two years from date of purchase. In addition, Bruno warrants that the motor, gear box and rail (the "Major Components") will be free from defects in materials and workmanship for a period of five years from the date of purchase.

The exclusive remedy for a defect in a Bruno Stairlift shall be the repair or replacement, at the option of Bruno, of the defective part or component. After the first 30 days of this warranty, only parts and components are covered. This warranty does not cover labor and other services after the initial 30 days. If repair or replacement of a Bruno Stairlift is not commercially practical or cannot be timely made, Bruno may elect to refund the purchase price of the Bruno Stairlift instead of repairing or replacing the Bruno Stairlift.

**IN NO EVENT SHALL BRUNO BE RESPONSIBLE FOR INDIRECT, INCIDENTAL OR CONSEQUENTIAL DAMAGES, WHETHER SUCH DAMAGES ARISE FROM CLAIMS BASED ON CONTRACT, WARRANTY, TORT (INCLUDING NEGLIGENCE), STRICT LIABILITY OR PRODUCT LIABILITY.** Some states do not allow the exclusion or limitation of incidental or consequential damages, so the above limitation or exclusion may not apply to you.

**ALL IMPLIED WARRANTIES, INCLUDING ANY WARRANTY OF MERCHANTABILITY OR FITNESS FOR A PARTICULAR PURPOSE, ARE LIMITED IN THEIR DURATION TO THE LENGTH OF THE WARRANTY STATED ABOVE FOR THE AFFECTED COMPONENT.** Some states do not allow limitations on how long an implied warranty lasts so the above limitation may not apply to you.

To obtain warranty service, you must follow these procedures:

1. Obtain return authorization by calling your local Bruno dealer;
2. Return the Bruno Stairlift, freight prepaid, to the address provided by your Bruno dealer or Bruno with proof of purchase indicating the date purchased.

Bruno will pay for shipping back to the purchaser within the continental United States and Canada if a defect in material or workmanship is discovered. Return freight and repair charges will be the responsibility of the purchaser if the problem is not covered by warranty.

This warranty does not cover damage or failure caused by misuse, abuse, accidents, physical damage, modifications not made by Bruno, damage in shipment, or repairs undertaken by anyone other than Bruno factory employees or authorized distributors. The "original purchaser" of a Bruno Stairlift that is leased or rented shall be the person or entity acting as the lessee or rental provider.

This warranty gives you specific legal rights, and you may also have other rights which vary from state to state. Bruno specifically does not authorize any person to extend the time or scope of this warranty.

For further information regarding this limited warranty, please contact Bruno by calling 1-800-882-8183 or writing to Bruno at the following address:

Bruno Independent Living Aids, Inc.®  
Attention: Service Department  
1780 Executive Drive, Post Office Box 84  
Oconomowoc, WI 53066 USA

# *First in Performance. Built to Last!*



**Straight & Custom  
Curved-Rail Stairlifts**



**Vertical Platform Lift**



**Over 25 Different  
Vehicle Lift Solutions**



**Turning Automotive Seating**

Bruno Independent Living Aids, Inc.<sup>®</sup>  
1780 Executive Drive, P.O. Box 84, Oconomowoc, WI 53066  
262-567-4990 • FAX: 262-953-5501 • [www.bruno.com](http://www.bruno.com)

 **BRUNO**<sup>™</sup>  
for your independence

©2006 Bruno Independent Living Aids, Inc.<sup>®</sup> All illustrations and specifications in this brochure are based on the latest product information available at the time of publication. Bruno Independent Living Aids, Inc.<sup>®</sup> reserves the right to make changes at any time without notice. Manual Back Cover 8/06-2.

P/N 2100-O